



注册号：1001366  
ISO9001 认证企业

# 铝合金地板

ALUMINUM FLOOR



## HUATONG ACCESS FLOOR SYSTEM

常州华通新立地板有限公司  
CHANGZHOU HUATONG XINLI FLOORING CO.,LTD.



## 真诚服务 创造美好环境

### 企业概述

常州华通新立地板有限公司成立于1980年，是亚洲最大的OA网络地板、高架活动地板、铝合金地板以及计算机机房设备的生产和供应商，是ISO9001认证企业。公司拥有员工800余人。一贯以来我们都是秉承；质量第一，价格竞争，供货和售后服务一流的经营理念来为我们的客户服务。产品大量应用于国家级大型工程中，并远销美国、日本、菲律宾、新加坡、沙特、英国、瑞士等国家和地区。

我们生产工艺先进，设备一流，生产出高品质的产品是我们的目标，为我们的客户提供品质稳定，数量充足的货源是我们的理想，为我们的客户提供优秀的服务是我们的愿望。

#### **CHANGZHOU HUATONG XINLI FLOORING CO.,LTD.**

Established in 1980, is the largest manufacturer and supplier of OA floor, raised floor, aluminum floor and computer room equipments in Asia. As an ISO9001 certified floor manufacturer, we have more than 800 employees. For a long time, we have been running under the principle of providing clients with top quality products, competitive price, timely delivery and satisfactory follow-up. Our products were largely used for big projects of national class, and exported to America, Japan, Philippine, Singapore, Saudi Arabia, England, Switzerland, etc.

With advanced technology and first-class facilities, we hold as our goal to create high quality products. It is our ideal to supply sufficient and reliable source of products and it is our aspiration to supply best services for our clients.

华通厂区  
HUATONG SCENES



# 平板

## BLIND PANEL

“华通”铝合金地板用在要求极高的工作场所，平板的格状结构能够有效地分散机械设备的重量，每块平板的尺寸精确，方便调换且经久耐用，能满足半导体洁净室和其它生产场所的承重需求。

“HUATONG” Aluminum panel is used in severely demanded work places. The grid structure of the blind panel can disperse the weight of mechanism equipments effectively. Each blind panel is of accurate dimension. It's durable and can be easily exchanged. The blind panel can meet the load requirement of semiconductor clean room and other work places.

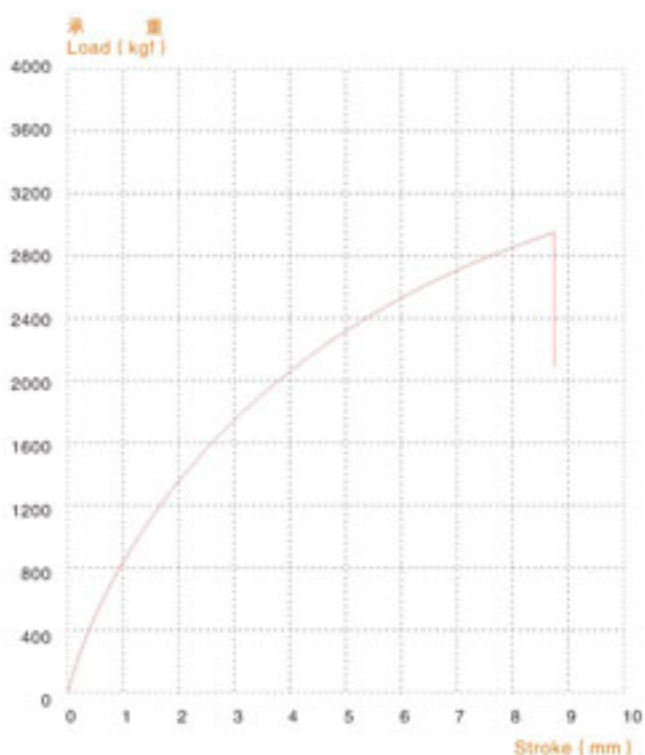
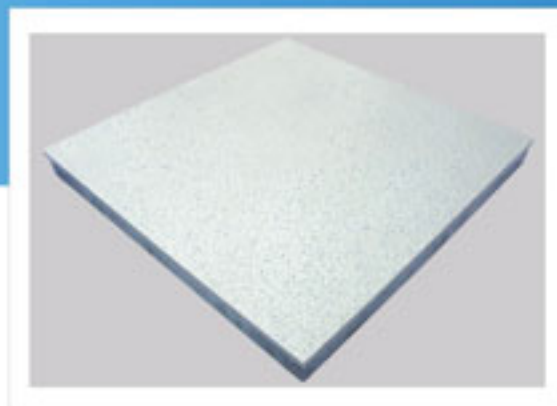

### 优点(Advantages):

- ◆ 尺寸精确，易于调换  
Accurate dimension, easily exchanged
- ◆ A1级建材（不燃性物质）  
Class A construction material (incombustible)
- ◆ 喷涂物质多样  
Various painting material
- ◆ 工艺独特  
Unique crafts
- ◆ 成本低，性能好  
Low cost, good performance
- ◆ 经久耐用  
Durable

型号 Type	尺寸 (贴面 mm) Size(Tile mm)	集中荷载kgf(ib.f) Concentrated load		极限荷载kgf(ib.f) Ultimate load		滚动磨损量 (mm) Rolling Beam Deflection
		中心 Center	1/2边 1/2 Edge	中心 Center	1/2边 1/2 Edge	
HDL300	600×600×32 (贴面/Tile 2.0)	422(930)	386(851)	886(1953)	849(1871)	0.015
HDL500	600×600×37 (贴面/Tile 2.0)	651(1435)	563(1241)	1367(3013)	1239(2731)	0.013
HDL700	600×600×42 (贴面/Tile 2.0)	895(1973)	792(1746)	1880(4144)	1742(3839)	0.016
HDL800	600×600×50 (贴面/Tile 2.0)	968(2133)	891(1964)	2033(4481)	1960(4320)	0.015
HDL1000	600×600×50 (贴面/Tile 2.0)	1358(2993)	1145(2524)	2852(6286)	2519(5552)	0.014
HDL1200	600×600×57 (贴面/Tile 2.0)	1439(3172)	1321(2911)	3022(6660)	2906(6405)	0.016
HDL1500	600×600×57 (贴面/Tile 2.0)	1763(3886)	1685(3714)	3702(8159)	3707(8170)	0.012
HDL2000	600×600×57 (贴面/Tile 2.0)	2467(5437)	2259(4979)	5181(11419)	4970(10954)	0.013

# 格栅板

## GRATING PANEL

“华通”铝合金格栅板有非常好的集中载荷，并且可以喷涂导静电涂层，抗腐蚀耐磨损。格栅设计通过50%的开孔，提供了自由的空气流动，这在洁净室里是令人满意的。裸板尺寸为600×600mm，为了空间的结构和空气平衡，格栅板可以和实心板、通风板互换。

“HUATONG” Aluminum Grating Panel is of good concentrated load and can be painted with conductive material. It is rust proof and can bear abrasion. It provides free air flowing with 50% opening of grating panel. The effect in clean room is satisfying. The dimension of the bare panel is 600\*600mm. Thinking of spatial structure and air balance, grating panel can be exchanged with blind panel and perforated panel.

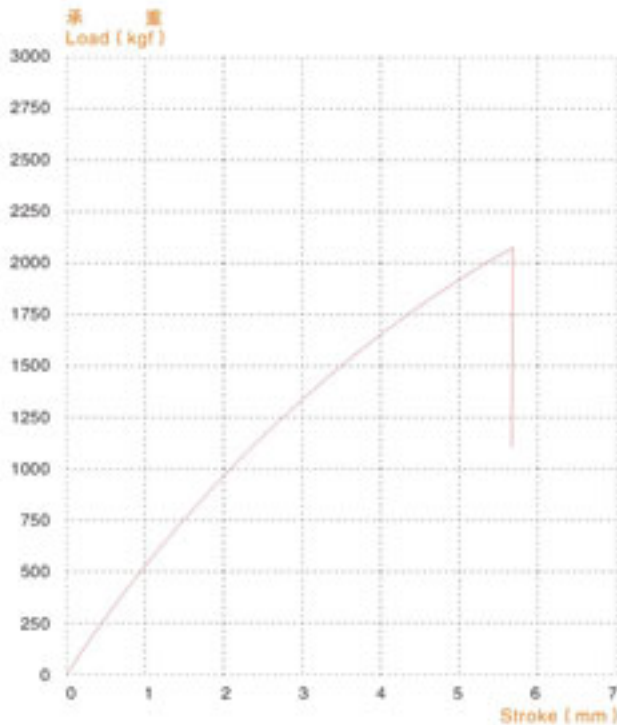
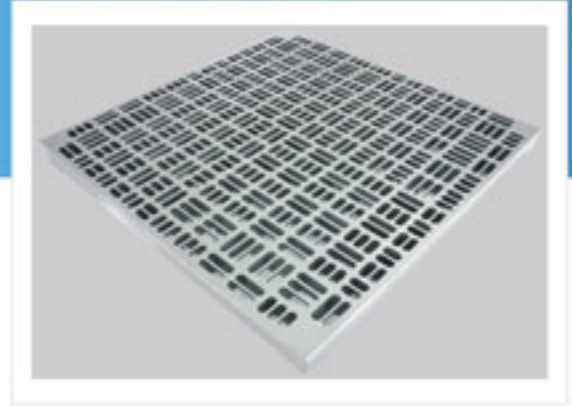

### 优点(Advantages):

- ◆ 高精度  
High precision
- ◆ A1级建筑材料（不燃性物质）  
Class A construction material(incombustible)
- ◆ 低变形，高载荷  
Little deflection and high load capacity
- ◆ 易切割  
Easily cut
- ◆ 经济、经久耐用，可回收  
Economical, durable, recoverable
- ◆ 完美的静电释放  
Excellent capacity of static dissipative
- ◆ 可和通风板配合使用  
Can be used with perforated panel

型号 Type	尺寸 Size	开孔率% Open Ratio(%)	集中载荷kgf(ib.f) Concentrated load		极限载荷kgf(ib.f) Ultimate load	
			中心 Center	1/2边 1/2 Edge	中心 Center	1/2边 1/2 Edge
HDL800	600×600×48	50	968(2133)	891(1964)	2033(4481)	1960(4320)
HDL1000	600×600×48	50	1358(2993)	1145(2524)	2852(6286)	2519(5552)
HDL1200	600×600×55	50	1439(3172)	1321(2911)	3022(6660)	2906(6405)

# 通风板

## PERFORATED PANEL

“华通”铝合金通风地板有多种型号可供选择，该通风地板有1024或1280个倒角孔，1024孔提供了18.09%~27.02%的通风率，1280孔提供了22.61%~33.77%的通风率。符合微机房和洁净室的通风要求。该通风板可以和其它地板互换。

Many types of "Huatong" Aluminium perforated panel should be available for your choice. With 1024 pieces or 1280 pieces concave holes, perforated panel of 1024 holes supplies the air flow rate of 18.09%~27.02% and the air flow rate of 1280 holes is 22.61%~33.77%. They can meet the air flow requirements of computer rooms and clean rooms. Furthermore, Huatong aluminium perforated panels assures the free interchange with other panels.

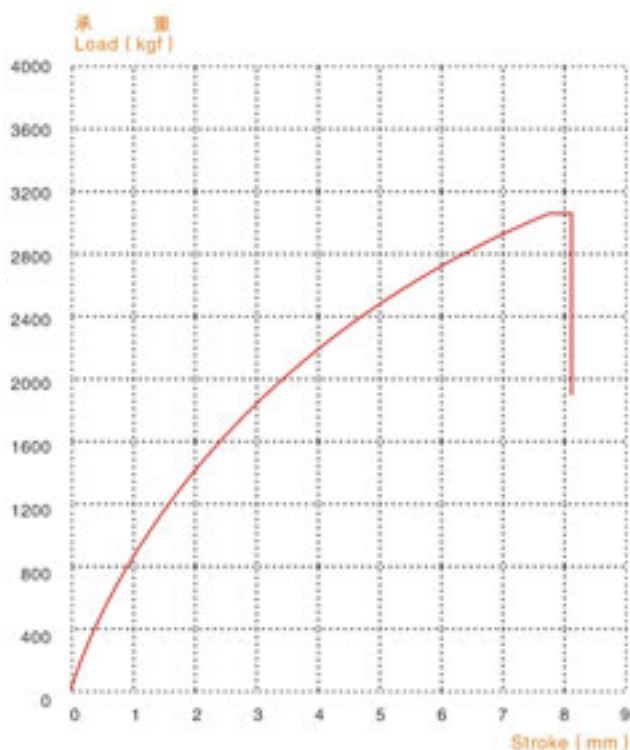
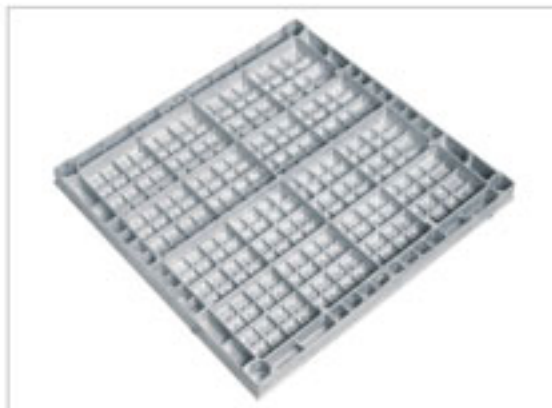
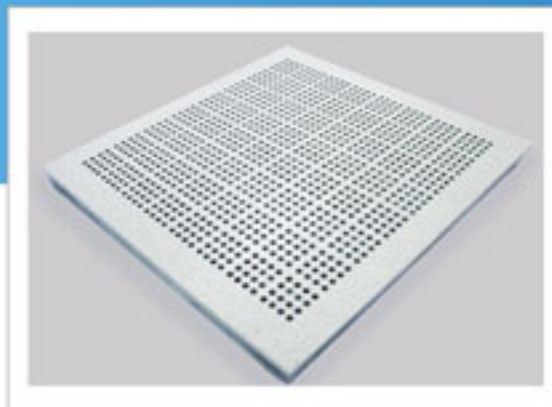

### 优点(Advantages):

- ◆ 做工精致  
Elaborated Made
- ◆ A1级建材（不燃性物质）  
Class A construction material (incombustible)
- ◆ 高承载、低变形  
High loading performance, Low deflection
- ◆ 可循环利用，经济  
Recycling, economical
- ◆ 便于以后开洞  
Easy for holes opening
- ◆ 良好的静电耗散性能  
Acceptable static dissipative performance
- ◆ 精确凿孔，凹形边缘  
Precise holes opening, concave design

型号 Type	尺寸(贴面 mm) Size(Tile mm)	通风孔尺寸 Perforated Hole Size	开孔率 % Open Ratio(%)	集中载荷kgf(ib.f) Concentrated load		极限载荷kgf(ib.f) Ultimate load		滚动磨损量 (mm) Rolling Beam Deflection
				中心 Center	1/2边 1/2 Edge	中心 Center	1/2边 1/2 Edge	
HDL800	600×600×50 (贴面/Tile 2.0)	Φ9.0 × 1024 (1280)	18.09 (22.61)	968 (2133)	891 (1964)	2033 (4481)	1960 (4320)	0.015
		Φ9.5 × 1024 (1280)	20.15 (25.19)					
		Φ10.0 × 1024 (1280)	22.33 (27.91)					
		Φ10.5 × 1024 (1280)	24.62 (30.78)					
HDL1000	600×600×50 (贴面/Tile 2.0)	Φ9.0 × 1024 (1280)	18.09 (22.61)	1358 (2993)	1145 (2524)	2852 (6286)	2519 (5552)	0.014
		Φ9.5 × 1024 (1280)	20.15 (25.19)					
		Φ10.0 × 1024 (1280)	22.33 (27.91)					
		Φ10.5 × 1024 (1280)	24.62 (30.78)					
HDL1200	600×600×57 (贴面/Tile 2.0)	Φ9.0 × 1024 (1280)	18.09 (22.61)	1439 (3172)	1321 (2911)	3022 (6660)	2906 (6405)	0.016
		Φ9.5 × 1024 (1280)	20.15 (25.19)					
		Φ10.0 × 1024 (1280)	22.33 (27.91)					
		Φ10.5 × 1024 (1280)	24.62 (30.78)					
HDL1500	600×600×57 (贴面/Tile 2.0)	Φ9.0 × 1024 (1280)	18.09 (22.61)	1763 (3886)	1685 (3714)	3702 (8159)	3707 (8170)	0.012
		Φ9.5 × 1024 (1280)	20.15 (25.19)					
		Φ10.0 × 1024 (1280)	22.33 (27.91)					
		Φ10.5 × 1024 (1280)	24.62 (30.78)					
HDL2000	600×600×57 (贴面/Tile 2.0)	Φ9.0 × 1024 (1280)	18.09 (22.61)	2467 (5437)	2259 (4979)	5181 (11419)	4970 (10954)	0.013
		Φ9.5 × 1024 (1280)	20.15 (25.19)					
		Φ10.0 × 1024 (1280)	22.33 (27.91)					
		Φ10.5 × 1024 (1280)	24.62 (30.78)					

# 通风特征

## AIR FLOW PERFORMANCE

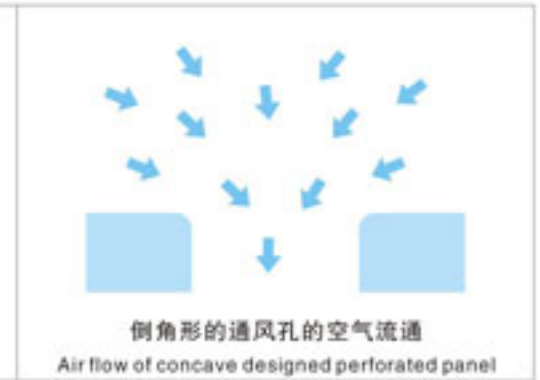
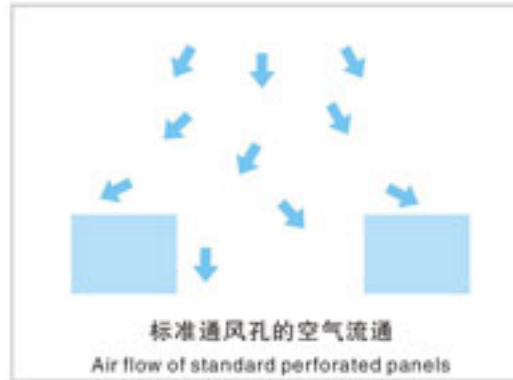

### 通风板

设计用于提供天花板和高架地板间的高速的、平稳的通风。

#### ■ 标准的：

标准的通风孔能使平稳的空气通过地板。

#### ■ 倒角形：

对比标准的通风孔，通过凹形孔的空气增加了，这样就减小了地板表面的不稳定。

### Perforated panel

Designed in order to meet the speedy and stable air flow requirements between ceiling and raised access floors.

#### ■ Standard

Air can go through the standard perforated panel stably.

#### ■ Concave designed

Compared with standard perforated panel, the air volume goes through the concave holes should be more and the whole system should be more stable.

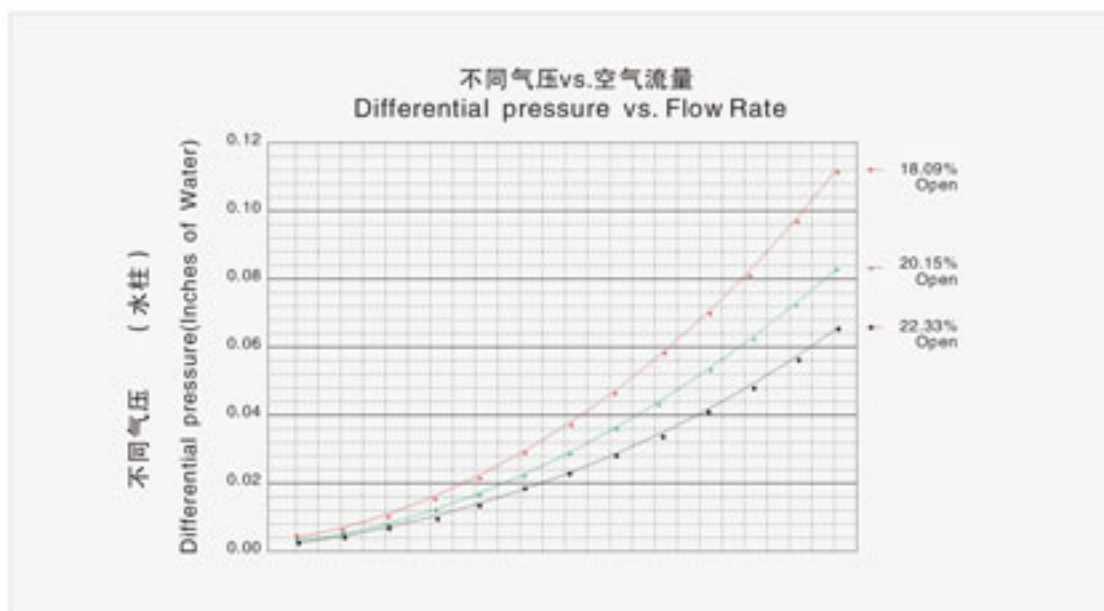

# 调节片

## DAMPER

通风板或格栅板有滑动节气阀，可保证工作场所或机器周边及室内的空气均匀平衡流动，便于调节，调节阀可以现场安装，也可在出厂时就预先装好。

Dampers under perforated panel can adjust the air flow in the working place or around the machine, the damper can be installed in the job site and can also be installed in the factory.

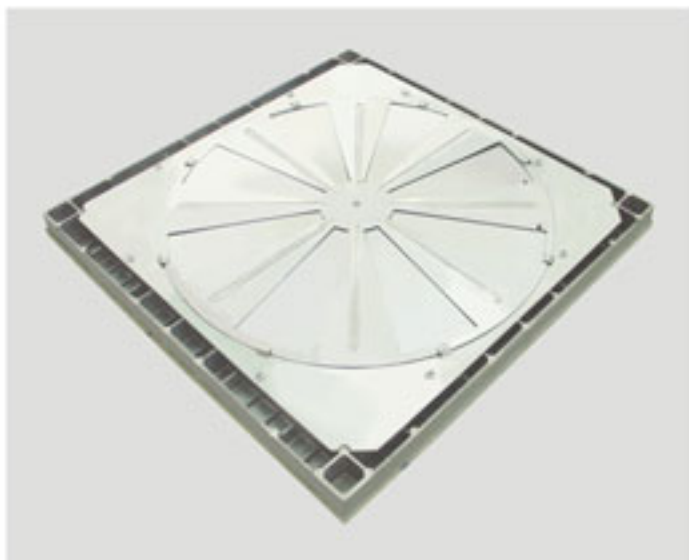
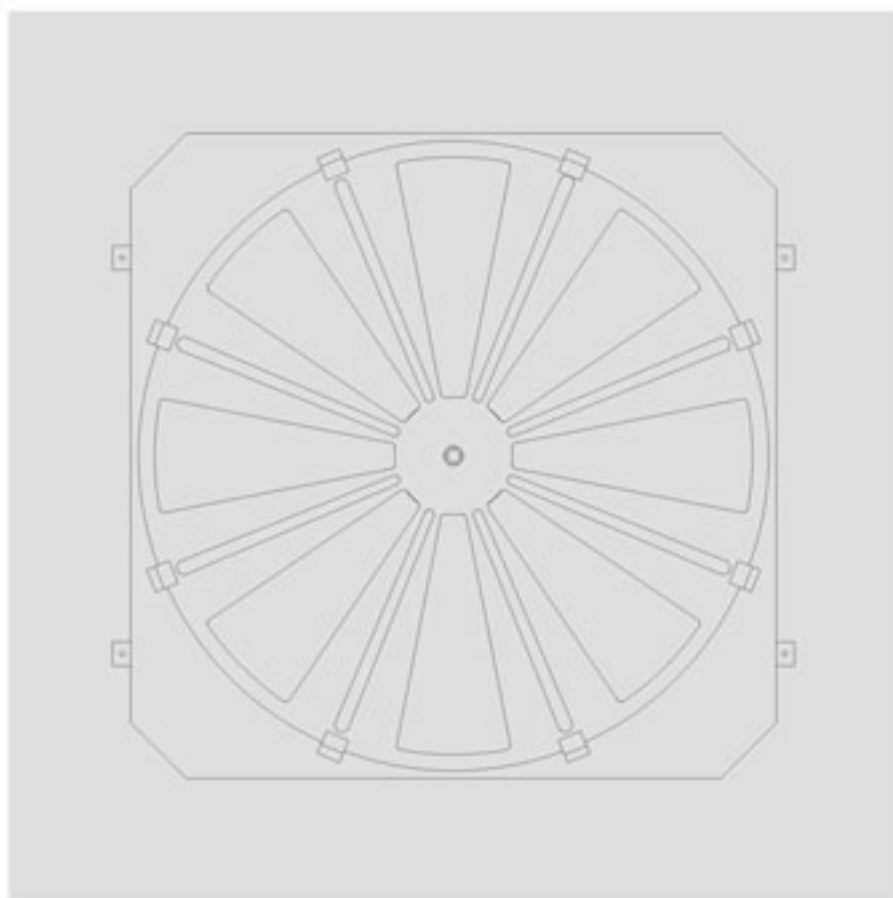

# 开孔系列

## CUT HOLES SERIES

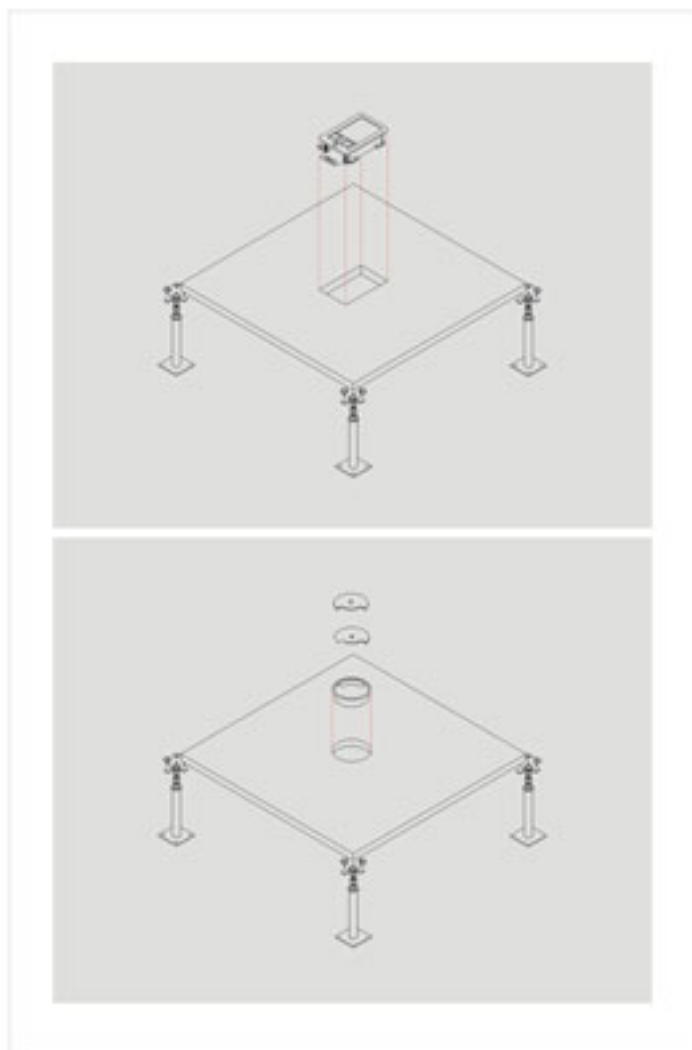

附带出线盒的铝合金地板，专门为需要有走线要求的洁净室（对空气洁净程度有高要求的实验室、半导体生产车间、医院手术室）等场所而设计，为您营造一个舒适、整洁、高效的工作环境，并且走线方便并配有多种出线盒，能优化布线设计。

Aluminum panel with outlet box is specially designed for clean room which requires wire casing (for those high demand for clean air clean rooms such as semiconductor production line and hospital), it can create a comfortable and high productivity working environment and is easy for wire casing. There are also different kinds of outlet box for various requirement for wire casing.

Outlet box-1

Outlet box-2

Outlet box-3

Outlet box-4

Outlet box-5



# 支架 横梁

## PEDESTAL & STRINGERS



### 支架系统

我司各系列支架可用于任何振动环境。

支架上托可采用未处理或静电喷涂。

管子也可采用未处理、静电喷涂或环氧喷涂。

基座也可采用未处理、静电喷涂或环氧喷涂。

高度:150-1500mm

### PEDESTAL SYSTEM

Our pedestal can be applied to any vibrating circumstance. The top part, tube, and base part of pedestal can all be kept unpainted, static painted or epoxy painted.

Height: 150-1500mm

### 横梁

该横梁可承担横向载重，不占地板空间，因其端部有槽口可配套地板尺寸，靠墙的横梁可截短后重新打孔再安装，如用于洁净室，该横梁可进行静电喷涂或环氧喷涂。

### STRINGERS

They can help to load the weight of access floor panels, as the holes of the end of them are well matched with the corner locks of the panels. They can also be shortened and installed when they join the wall. Suppose they are used in clean room, they can also be static or epoxy painted.

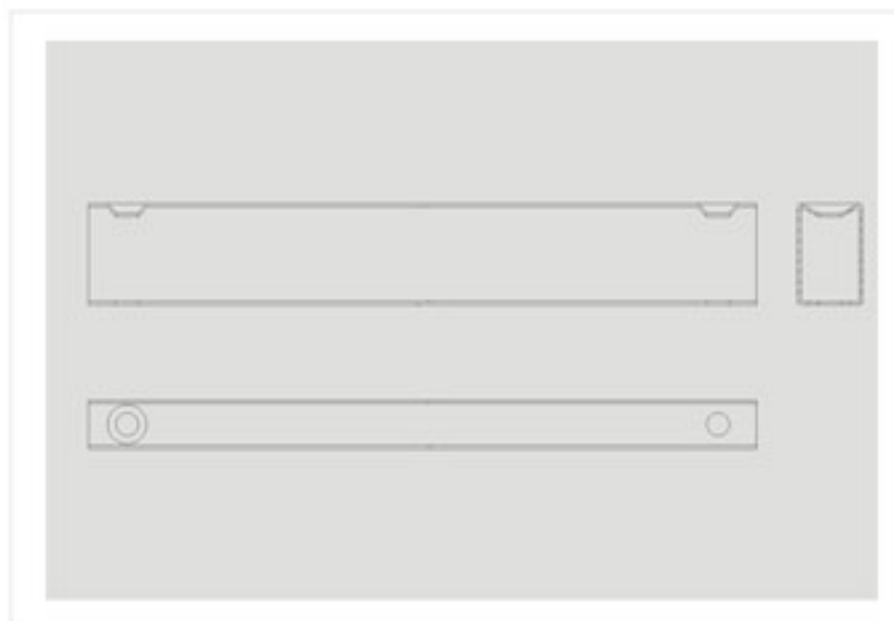

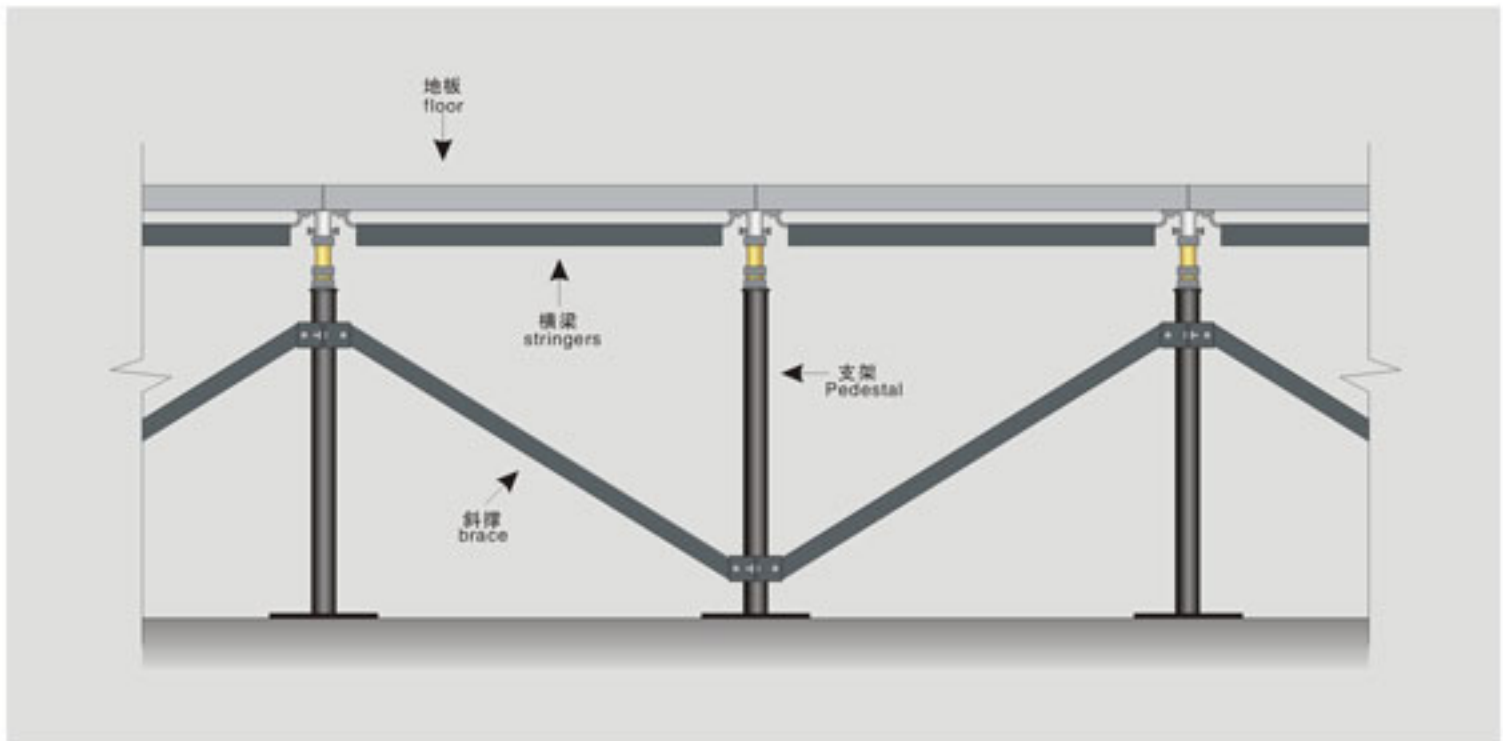

承重系统可采用带状或管状钢铁以斜三角形固定支架和底板，以防止剧烈运动时地板横向移动。

Understructures can be fixed by a triangle made up of pedestal and band-like or tube shaped steel, so as to prevent them from moving levelly.

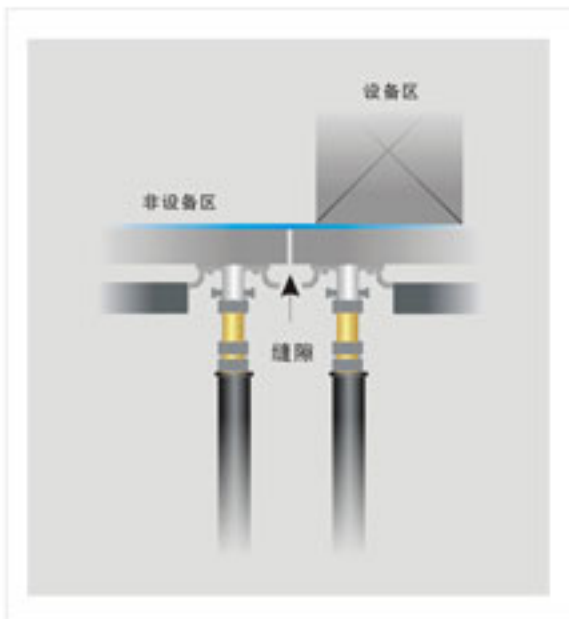

防振体系：将设备区域与非设备区域的高架地板进行隔离，避免设备运行时产生的振动传递到非设备区。

Seperate the raised floor between equipment area and non-equipment installed area to avoid the vibration from equipment influence non equipment installed area.

# 钢构系统

## STEEL FRAME SYSTEM

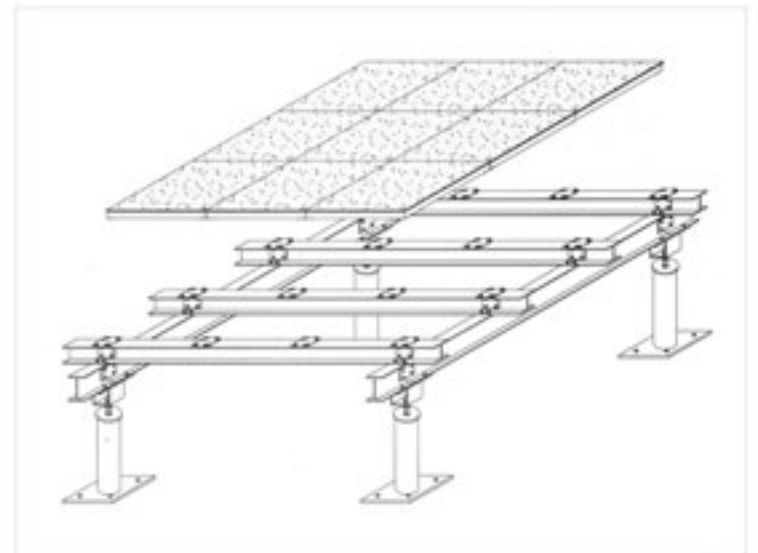
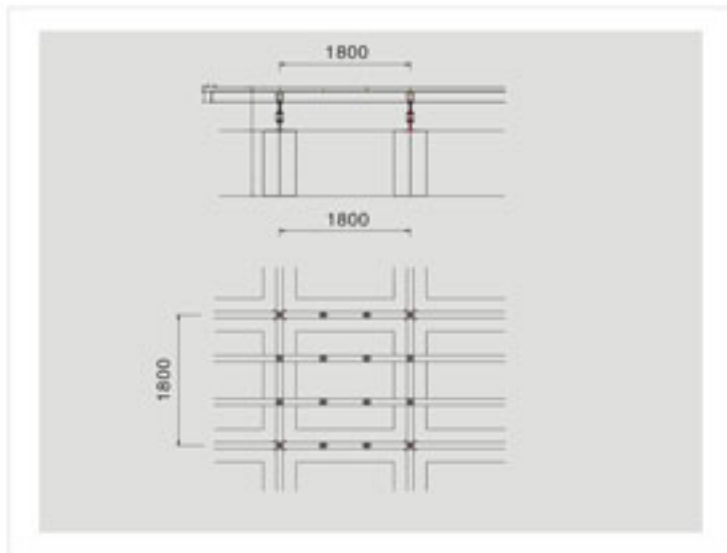

我们有我们专有独特的下部支撑系统。主要用于洁净室。上下可调节的横梁是“工”字型的，表面可以静电喷塑成环氧树脂喷涂。高度的调节是通过调节支撑上的螺钉来实现的。支撑底座可以通过螺钉固定在底层地面上，横梁的上下调节通过螺钉来紧固。同时在地板安装的同时，在横梁上铺上铝板和绝缘板。

Mainly used in clean room with special understructure system and "工" pattern adjustable stringer which can be epoxy coated. Stringer height to be adjusted by the screw on pedestal head and pedestal base to stick on the field by screw as well. When installing the panel, lay aluminum panel and insulated panel on the stringer.

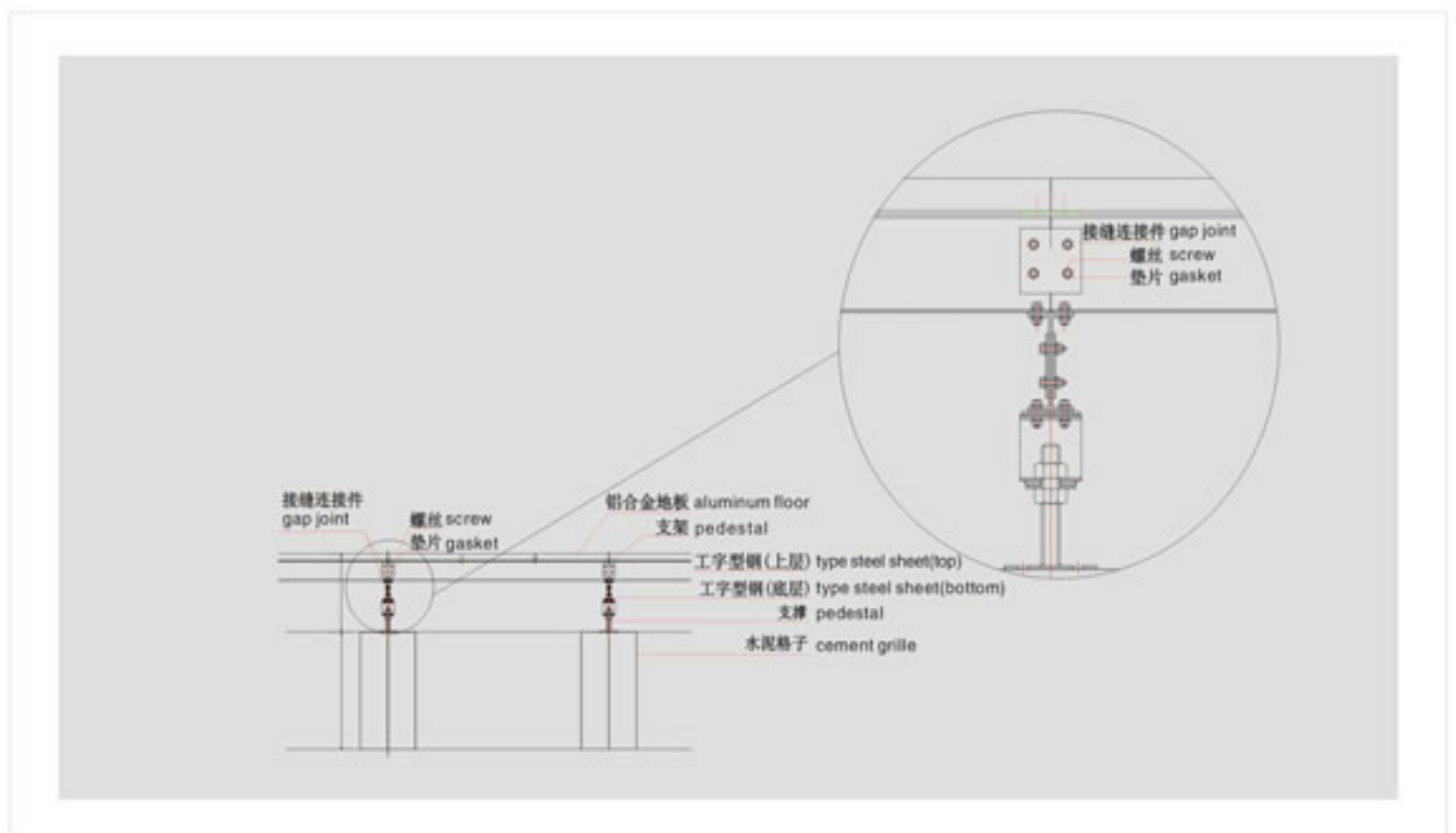

# 斜坡 台阶

## RAMP & STAIR

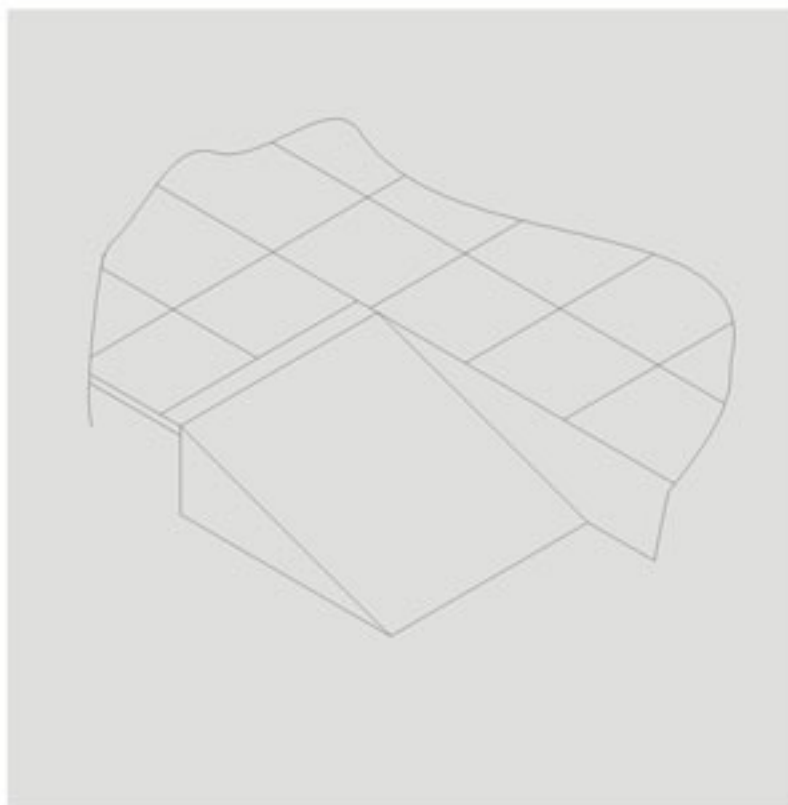

### 斜坡

斜坡的设计一般是用于将一些轻的机械和设备从底层地板移到架空地板上。由角钢和钢板组成，为了防滑，我们在上面粘贴地砖、木材或橡胶。

### RAMP

Ramp design is normally applied to move some light machine and equipment from structural floor to the surface of access floor panels, which are constructed of angle iron and steel sheet. In avoid of sliding, we stick floor tiles, wood or rubber on the surface of slope.

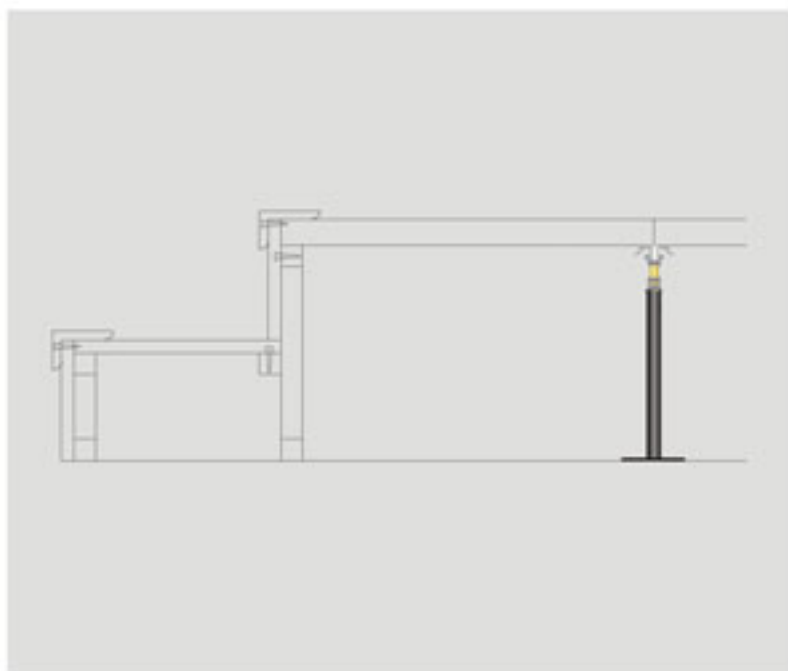

### 台阶

台阶的设计是为了帮助人们走过地板有落差的区域。主要原件为角钢和钢板。同时，在台阶上铺的地砖、木板或橡胶防滑。台阶的角落处我们也铺有防滑的材料。如果在和门相连的地方，可以增加一个平台区域。

### STAIR

Stair design is for helping people to pass through panels area with different height, meanwhile, floor tiles, wood sheet or rubber to avoid sliding. We also lay anti-sliding material on the corner of steps. A platform can be added in the connection area with door.

我们公司是集销售、安装为一体的现代化高架地板生产企业。作为高架地板中的一个高档品种，铝合金高架地板具有轻盈、易回收之特点，广泛应用于洁净室（对空气洁净程度有高要求的实验室、半导体生产车间、医院手术室等）。

Our company is specialized in manufacturing and installing raised access floor. As a super variety among various raised access floor panels, and with the characteristics of light weight and easy to be recycled, the aluminum raised floor panels are widely used in clean rooms (e.g. laboratory requiring critical air clean degree, semi-conductor workshops, and operationg rooms in hospital, etc.)



洁净室（一）▲  
clean rooms



洁净室（二）▲



洁净室（三）▲

# 工程实例

JOB REFERENCE

洁净室（四）▶



洁净室（五）▶





# HUATONG ACCESS FLOOR SYSTEM



Huatong Access Floor  
Tel: 86-519-86293436  
Fax: 86-519-88390326  
Url: <http://www.huatongfloor.com>  
Emai: [export@huatongfloor.com](mailto:export@huatongfloor.com)